



najwyższa jakość w każdym wymiarze

System polecany
przez:



Stowarzyszenie
Naukowo-Techniczne
Inżynierów i Techników
Przemysłu
Naftowego i Gazowego



Małopolski Cech
Rzemieślników
i Przedsiębiorców
Budowlanych



Korporacja Kominiarzy
Polskich Stowarzyszenie
Zawodowe
Oddział w Krakowie

System kominowy KS

Jednościenny system kominowy
do urządzeń grzewczych z otwartą
komorą spalania, opalanych gazem
lub olejem opałowym



Certyfikaty:

ISO 9001 : 2000

CE - CPD 89 / 106 / EWG



CE 1450



CE 0432

KOMINUS Sp. z o.o.

Łęzkowice 112

32 - 015 Kłaj

tel./fax +48 12 284 27 73

+48 12 284 45 44

www.kominus.com.pl

e-mail: biuro@kominus.com.pl

System kominowy KS

Jednościenny system kominowy do urządzeń grzewczych z otwartą komorą spalania, opalanych gazem lub olejem opałowym.

1. Wprowadzenie.

System kominowy KS jest nowoczesnym systemem kominowym spełniającym standardy Unii Europejskiej i wymogi norm zharmonizowanych PN-EN 1856-1. System charakteryzuje się wysokimi parametrami eksploatacyjnymi i jest przystosowany do pracy w ekstremalnych warunkach eksploatacji - odprowadzanie spalin mokrych z urządzeń opalanych gazem lub olejem opałowym. Charakterystyczną cechą bezpieczeństwa tego systemu jest jego odporność na pożar sadzy a także wysoka trwałość eksploatacyjna równa trwałości budynków lub budowli. Istotną cechą systemów jest wysoka szczelność i niezawodność działania oraz duża efektywność energetyczna. Stawia to ten rodzaj wyrobów w grupie wyrobów o najwyższym standardzie w Unii Europejskiej, co zostało potwierdzone przez wyspecjalizowane jednostki notyfikowane krajowe i zagraniczne.

Elementy wkładów jednościennych systemu KS wykonywane ze stali szlachetnych, są systemem rur i kształtek oraz akcesoriów uzupełniających.

Przewody spalinowe wykonane w oparciu o elementy systemu KS stosowane są w celu zabezpieczenia wewnętrznych ścian kominów przed destruktywnym działaniem skroplin powstających w wyniku spalania gazu i oleju opałowego w nowoczesnych urządzeniach grzewczych.

Elementy systemu KS doskonale sprawdzają się w przypadkach remontu (doszczelnienia) kanałów wentylacyjnych.

Technologia wykonania poszczególnych elementów pozwala na dowolną konfigurację przewodów spalinowych i wentylacyjnych oraz zapewnia zamontowanie ich w stosunkowo prosty, szybki i mało uciążliwy sposób. Daje to możliwość modernizacji kotłowni bez dużej ingerencji w strukturę budowlaną w celu przystosowania istniejących kominów do nowych warunków.

Dobór materiałów, konstrukcja oraz procesy technologiczne stosowane w produkcji elementów systemu KS, mają na celu dostosowanie parametrów przewodu spalinowego do zmiennych warunków pracy oraz różnej temperatury spalin. Wymienione założenia są osiągalne dzięki przestrzeganiu najsurowszych reżimów technologicznych potwierdzonych odpowiednimi certyfikatami oraz dopuszczeniami do stosowania w budownictwie.

2. Podstawowa charakterystyka systemu KS.

Wyrób:	System kominowy KS - produkcji firmy Kominus
Zakres średnic:	DN 80 – 500 mm
Gatunek materiału:	1.4404
Grubość materiału:	≥ 0,6 mm
Klasa temperatury:	T450
Klasa ciśnienia:	N1
Odporność na działanie kondensatu:	W
Odporność na korozję:	V _m
Odporność na pożar sadzy:	G - 1000°C
Oznaczenie systemu KS wg PN-EN 1856-1	KOMINUS PN EN 1856-1 T450 N1 W V _m L50050 G500 DN 80 – DN 500 CE ₁₄₅₀

3. Charakterystyka systemu KS na indywidualne zamówienie.

Zastosowanie:	Kominy systemu KS wykonane z wysokogatunkowej stali szlachetnej, stosowane są w celu zapewnienia długotrwałego i bezpiecznego odprowadzania spalin z urządzeń grzewczych
Rodzaj paliwa:	Gaz / olej opałowy
Klasa temperatury:	T 450
Tryb pracy:	Podciśnienie
Gatunek stali :	1.4404 / 1.4301 / pozostałe posiadające dopuszczenia do tego typu zastosowań
Grubość stali rdzenia:	0.4mm – 1.0mm
Rodzaj połączenia:	Kielichowe

4. Kody katalogowe firmy Kominus.



Tabela 1

Symbol	Gr. izolacji
I3	30mm
I5	50mm
I7	75mm

Tabela 2

Symbol	Grubość
A	0,4 mm
B	0,5 mm
C	0,6 mm
D	0,8 mm
E	1,0 mm
F	1,5 mm
G	2,0 mm
X	inne

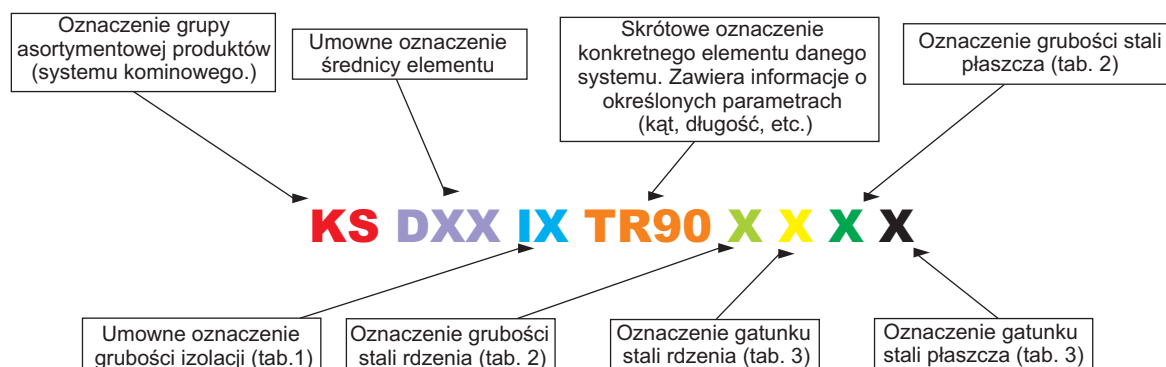
Tabela 3

Symbol	Gatunek
1	1,4404
2	1,4301
3	1,4509
4	1,4828
5	ocynk
6	ocynk RAL
7	miedź
8	aluminium
9	S235JRGZ
0	inne

5. Połączenie elementów systemu KS.

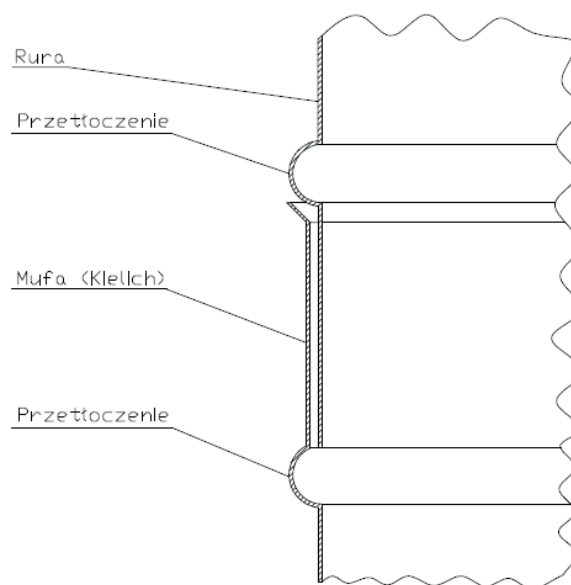

6. Zalety stosowania systemu KS.

W związku z dążeniem do oszczędności energii oraz większej uwadze skierowanej na ochronę środowiska, obserwuje się ciągły rozwój techniki grzewczej polegający na nieustannym unowocześnianiu urządzeń grzewczych co wywiera bardzo duży wpływ na funkcjonowanie kominów.

Wyżej wymieniona sytuacja ma wpływ na parametry spalin. W związku z rozwojem techniki grzewczej i zmianą parametrów spalin następuje proces niszczenia tradycyjnych kominów murowanych, nieprzystosowanych do nowych warunków pracy.

Szansę na wykorzystanie istniejącego komina murowanego, daje wykorzystanie systemu KS, który zabezpieczy go przed postępującym procesem niszczenia.

Uzbrojenie starego komina za pomocą elementów systemu KS, zapewnia osiągnięcie wymaganych parametrów, gwarantujących prawidłową i bezpieczną pracę przewodu.

Do podstawowych zalet wkładów kominowych w systemie KS należy zaliczyć:

- łatwy i szybki montaż,
- szeroki przedział produkowanych średnic – daje to możliwość odpowiedniego doboru przekroju przewodu w stosunku do urządzenia. W przypadku starych kominów na ogół przekrój powinien zostać zmniejszony,
- szybkie nagrzewanie – przy szybkim nagrzewaniu ścianek przewodu ograniczone zostaje zjawisko skraplania pary wodnej zawartej w spalinach ponad to szybkie nagrzewanie zapewnia niemalże natychmiastowe uzyskanie wymaganego ciągu.

7. Usytuowanie wylotów komina wg PN.

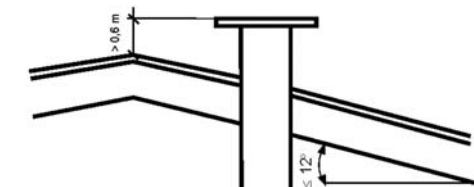

1. Przy dachach płaskich o kącie nachylenia połaci dachowych nie większym niż 12° , niezależnie od konstrukcji dachu, wyloty przewodów powinny się znajdować nie mniej niż o 0,6 m wyżej od poziomu kalenicy lub obrzeży budynku przy dachach wgnębionych

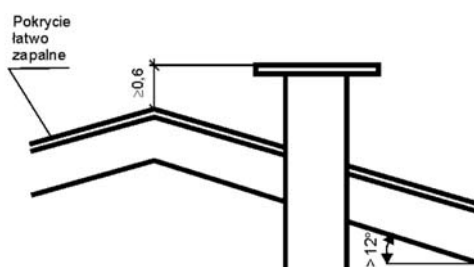

2. Przy dachach stromych o kącie nachylenia połaci powyżej 12° i pokryciu łatwo zapalnym, wyloty przewodów powinny się znajdować na wysokości co najmniej 0,6m wyżej od poziomu kalenicy

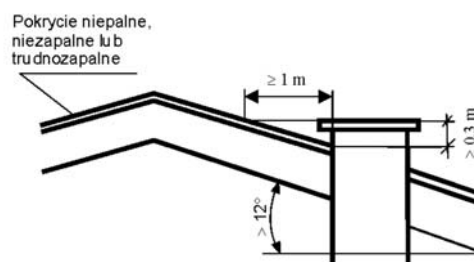

3. Przy dachach stromych o kącie nachylenia połaci dachowych powyżej 12° i pokryciu niepalnym, niezapalnym lub trudno zapalnym, wyloty przewodów powinny znajdować się na wysokości co najmniej 0,3 m. od powierzchni dachu, oraz w odległości co najmniej 1,0 m. od tej powierzchni mierzonej w kierunku poziomym.

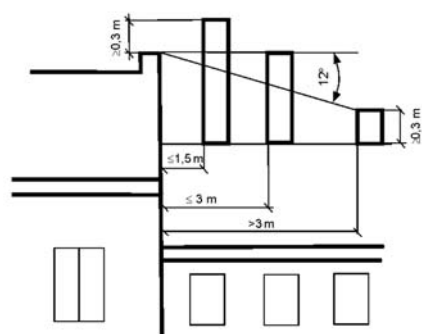

4. Przy usytuowaniu komina obok elementu budynku stanowiącego przeszkodę (zasłonę), dla prawidłowego działania przewodów ich wyloty powinny się znajdować się:
 - ponad płaszczyznę wyprowadzoną pod kątem 12° w dół od poziomu najwyższej przeszkody dla kominów znajdujących się powyżej 3,0m od przeszkody,
 - co najmniej na poziomie górnej krawędzi przeszkody dla kominów usytuowanych w odległości 1,5 – 3,0 m od przeszkody,
 - co najmniej 0,3m wyżej od górnej krawędzi przeszkody dla kominów znajdujących się do 1,5 m od tej przeszkody.

Wymagania dotyczące usytuowania wylotów kominów zostały podane w oparciu o przepisy obowiązujące na terenie Rzeczypospolitej Polskiej. W przypadku instalacji kominów na obszarze innych krajów należy stosować przepisy obowiązujące na ich terytorium.

8. Typowe zestawienia elementów.

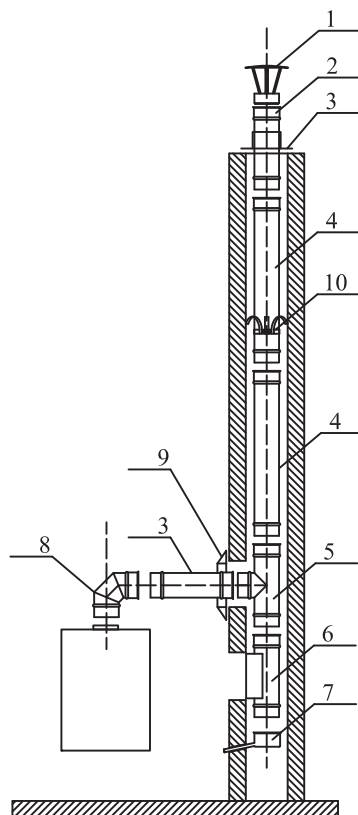

Poz.	Kod	Element
1.	D	Daszek
2.	R05	Rura L=500 mm
3.	P	Przeście dachowe
4.	R10	Rura L=1000 mm
5.	TR90	Trójnik 90°
6.	W	Wyczystka
7.	O	Denko z odskraplaczem
8.	K90	Kolano 90°
9.	RZ	Rozeta
10.	OC	Obejma centrująca

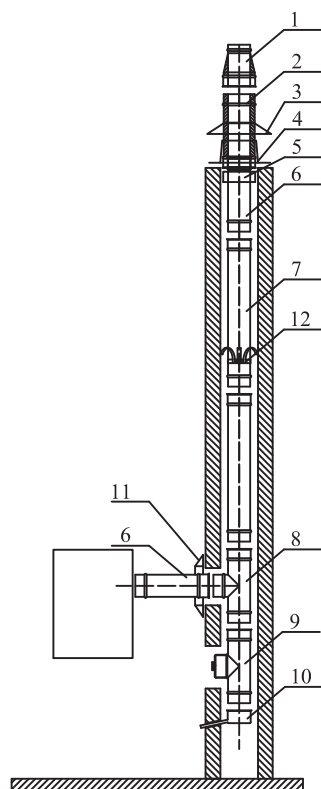

Poz.	Kod	Element
1.	U	Ustnik (KD)
2.	R05	Rura L=500 mm (KD)
3.	OPD	Ośłona przeciwdeszczowa
4.	P	Przeście dachowe
5.	ZID	Zakończenie izolacji dolne (KD)
6.	R05	Rura L=500 mm
7.	R10	Rura L=1000 mm
8.	TR90	Trójnik 90°
9.	WTD	Wyczystka trójnikowa
10.	O	Denko z odskraplaczem
11.	RZ	Rozeta
12.	OC	Obejma centrująca

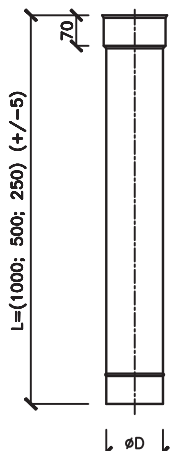
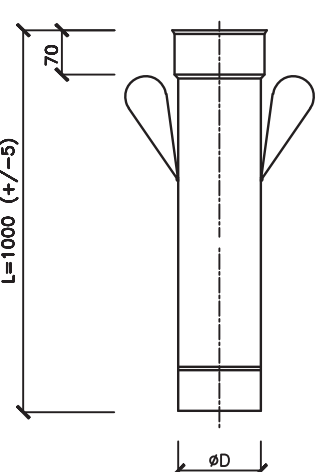
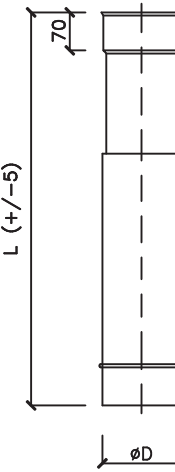
SYMBOL	NAZWA	RYSUNEK I WYMIARY																																																																																																				
R10 R05 R02	Rura prosta	 <p style="text-align: right;">KOMINUS®</p> <p style="text-align: right;">Tabela wymiarów</p> <table border="1" style="width: 100%; text-align: center;"> <tr> <td>øD mm</td> <td>80</td><td>90</td><td>100</td><td>113</td><td>120</td><td>130</td><td>140</td><td>150</td><td>160</td><td>180</td><td>200</td><td>225</td><td>250</td><td>280</td><td>300</td><td>350</td><td>400</td><td>450</td><td>500</td> </tr> </table>	øD mm	80	90	100	113	120	130	140	150	160	180	200	225	250	280	300	350	400	450	500																																																																																
øD mm	80	90	100	113	120	130	140	150	160	180	200	225	250	280	300	350	400	450	500																																																																																			
RU	Rura prosta z uszami	 <p style="text-align: right;">KOMINUS®</p> <p style="text-align: right;">Tabela wymiarów</p> <table border="1" style="width: 100%; text-align: center;"> <tr> <td>øD mm</td> <td>80</td><td>90</td><td>100</td><td>110</td><td>120</td><td>130</td><td>140</td><td>150</td><td>160</td><td>180</td><td>200</td><td>225</td><td>250</td><td>280</td><td>300</td><td>350</td><td>400</td><td>450</td><td>500</td> </tr> </table>	øD mm	80	90	100	110	120	130	140	150	160	180	200	225	250	280	300	350	400	450	500																																																																																
øD mm	80	90	100	110	120	130	140	150	160	180	200	225	250	280	300	350	400	450	500																																																																																			
RT	Rura teleskopowa	 <p style="text-align: right;">KOMINUS®</p> <p style="text-align: right;">Tabela wymiarów</p> <table border="1" style="width: 100%; text-align: center;"> <tr> <td>øD mm</td> <td>80</td><td>90</td><td>100</td><td>113</td><td>120</td><td>130</td><td>140</td><td>150</td><td>160</td><td>180</td><td>200</td><td>225</td><td>250</td><td>280</td><td>300</td><td>350</td><td>400</td><td>450</td><td>500</td> </tr> <tr> <td></td> <td colspan="5"></td> <td colspan="2">L_{min}</td> <td colspan="2">L_{max}</td> <td colspan="10"></td> </tr> <tr> <td></td> <td colspan="5"></td> <td colspan="2">1070</td> <td colspan="2">1900</td> <td colspan="10"></td> </tr> <tr> <td></td> <td colspan="5"></td> <td colspan="2">870</td> <td colspan="2">1500</td> <td colspan="10"></td> </tr> <tr> <td></td> <td colspan="5"></td> <td colspan="2">570</td> <td colspan="2">900</td> <td colspan="10"></td> </tr> </table>	øD mm	80	90	100	113	120	130	140	150	160	180	200	225	250	280	300	350	400	450	500							L _{min}		L _{max}																		1070		1900																		870		1500																		570		900											
øD mm	80	90	100	113	120	130	140	150	160	180	200	225	250	280	300	350	400	450	500																																																																																			
						L _{min}		L _{max}																																																																																														
						1070		1900																																																																																														
						870		1500																																																																																														
						570		900																																																																																														

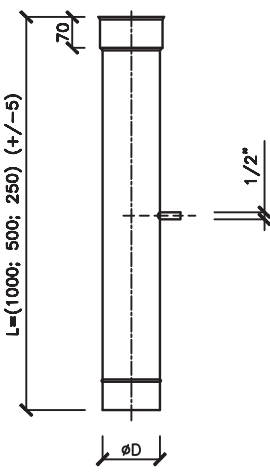
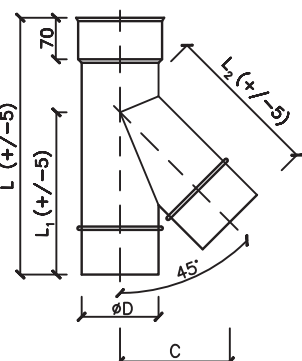
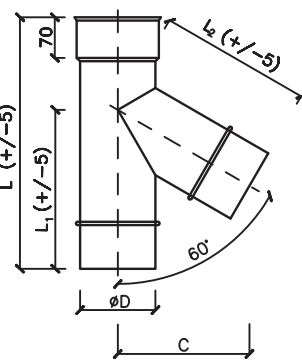
SYMBOL	NAZWA	RYSUNEK I WYMIARY																																																																																																				
RKC	Rura z króćcem pomiarowym 1/2"	 <p style="text-align: right;">KOMINUS®</p> <p style="text-align: right;">Tabela wymiarów</p> <table border="1" style="width: 100%; text-align: center;"> <tr> <td>ØD mm</td> <td>80</td><td>90</td><td>100</td><td>113</td><td>120</td><td>130</td><td>140</td><td>150</td><td>160</td><td>180</td><td>200</td><td>225</td><td>250</td><td>280</td><td>300</td><td>350</td><td>400</td><td>450</td><td>500</td> </tr> </table>	ØD mm	80	90	100	113	120	130	140	150	160	180	200	225	250	280	300	350	400	450	500																																																																																
ØD mm	80	90	100	113	120	130	140	150	160	180	200	225	250	280	300	350	400	450	500																																																																																			
TR45	Trójnik 45°	 <p style="text-align: right;">KOMINUS®</p> <p style="text-align: right;">Tabela wymiarów</p> <table border="1" style="width: 100%; text-align: center;"> <tr> <td>ØD mm</td> <td>80</td><td>90</td><td>100</td><td>113</td><td>120</td><td>130</td><td>140</td><td>150</td><td>160</td><td>180</td><td>200</td><td>225</td><td>250</td><td>280</td><td>300</td><td>350</td><td>400</td><td>450</td><td>500</td> </tr> <tr> <td>L mm</td> <td>315</td><td>330</td><td>345</td><td>360</td><td>375</td><td>390</td><td>410</td><td>425</td><td>440</td><td>470</td><td>500</td><td>540</td><td>580</td><td>630</td><td>660</td><td>730</td><td>810</td><td>890</td><td>960</td> </tr> <tr> <td>L₁ mm</td> <td>210</td><td>222</td><td>236</td><td>250</td><td>263</td><td>276</td><td>290</td><td>304</td><td>317</td><td>344</td><td>371</td><td>406</td><td>439</td><td>480</td><td>507</td><td>575</td><td>642</td><td>710</td><td>778</td> </tr> <tr> <td>L₂ mm</td> <td>210</td><td>222</td><td>236</td><td>250</td><td>263</td><td>276</td><td>290</td><td>304</td><td>317</td><td>344</td><td>371</td><td>406</td><td>439</td><td>480</td><td>507</td><td>575</td><td>642</td><td>710</td><td>778</td> </tr> <tr> <td>C mm</td> <td>136</td><td>144</td><td>153</td><td>162</td><td>171</td><td>179</td><td>188</td><td>197</td><td>206</td><td>223</td><td>241</td><td>264</td><td>285</td><td>312</td><td>329</td><td>373</td><td>417</td><td>461</td><td>505</td> </tr> </table>	ØD mm	80	90	100	113	120	130	140	150	160	180	200	225	250	280	300	350	400	450	500	L mm	315	330	345	360	375	390	410	425	440	470	500	540	580	630	660	730	810	890	960	L ₁ mm	210	222	236	250	263	276	290	304	317	344	371	406	439	480	507	575	642	710	778	L ₂ mm	210	222	236	250	263	276	290	304	317	344	371	406	439	480	507	575	642	710	778	C mm	136	144	153	162	171	179	188	197	206	223	241	264	285	312	329	373	417	461	505
ØD mm	80	90	100	113	120	130	140	150	160	180	200	225	250	280	300	350	400	450	500																																																																																			
L mm	315	330	345	360	375	390	410	425	440	470	500	540	580	630	660	730	810	890	960																																																																																			
L ₁ mm	210	222	236	250	263	276	290	304	317	344	371	406	439	480	507	575	642	710	778																																																																																			
L ₂ mm	210	222	236	250	263	276	290	304	317	344	371	406	439	480	507	575	642	710	778																																																																																			
C mm	136	144	153	162	171	179	188	197	206	223	241	264	285	312	329	373	417	461	505																																																																																			
TR60	Trójnik 60°	 <p style="text-align: right;">KOMINUS®</p> <p style="text-align: right;">Tabela wymiarów</p> <table border="1" style="width: 100%; text-align: center;"> <tr> <td>ØD mm</td> <td>80</td><td>90</td><td>100</td><td>113</td><td>120</td><td>130</td><td>140</td><td>150</td><td>160</td><td>180</td><td>200</td><td>225</td><td>250</td><td>280</td><td>300</td><td>350</td><td>400</td><td>450</td><td>500</td> </tr> <tr> <td>L mm</td> <td>289</td><td>301</td><td>314</td><td>326</td><td>338</td><td>351</td><td>363</td><td>375</td><td>388</td><td>413</td><td>437</td><td>468</td><td>499</td><td>536</td><td>561</td><td>623</td><td>684</td><td>746</td><td>808</td> </tr> <tr> <td>L₁ mm</td> <td>178</td><td>188</td><td>198</td><td>208</td><td>218</td><td>228</td><td>237</td><td>247</td><td>257</td><td>277</td><td>296</td><td>322</td><td>345</td><td>375</td><td>394</td><td>443</td><td>493</td><td>542</td><td>591</td> </tr> <tr> <td>L₂ mm</td> <td>178</td><td>188</td><td>198</td><td>208</td><td>218</td><td>228</td><td>237</td><td>247</td><td>257</td><td>277</td><td>296</td><td>322</td><td>345</td><td>375</td><td>394</td><td>443</td><td>493</td><td>542</td><td>591</td> </tr> <tr> <td>C mm</td> <td>144</td><td>152</td><td>160</td><td>168</td><td>176</td><td>184</td><td>192</td><td>200</td><td>208</td><td>224</td><td>239</td><td>261</td><td>279</td><td>303</td><td>319</td><td>358</td><td>399</td><td>439</td><td>478</td> </tr> </table>	ØD mm	80	90	100	113	120	130	140	150	160	180	200	225	250	280	300	350	400	450	500	L mm	289	301	314	326	338	351	363	375	388	413	437	468	499	536	561	623	684	746	808	L ₁ mm	178	188	198	208	218	228	237	247	257	277	296	322	345	375	394	443	493	542	591	L ₂ mm	178	188	198	208	218	228	237	247	257	277	296	322	345	375	394	443	493	542	591	C mm	144	152	160	168	176	184	192	200	208	224	239	261	279	303	319	358	399	439	478
ØD mm	80	90	100	113	120	130	140	150	160	180	200	225	250	280	300	350	400	450	500																																																																																			
L mm	289	301	314	326	338	351	363	375	388	413	437	468	499	536	561	623	684	746	808																																																																																			
L ₁ mm	178	188	198	208	218	228	237	247	257	277	296	322	345	375	394	443	493	542	591																																																																																			
L ₂ mm	178	188	198	208	218	228	237	247	257	277	296	322	345	375	394	443	493	542	591																																																																																			
C mm	144	152	160	168	176	184	192	200	208	224	239	261	279	303	319	358	399	439	478																																																																																			

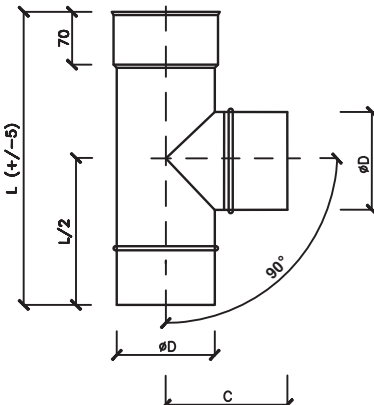
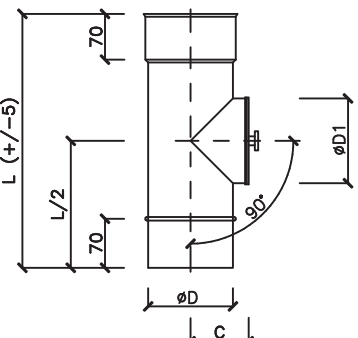
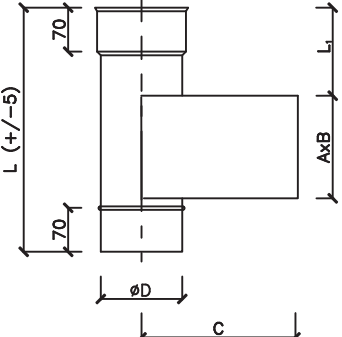
SYMBOL	NAZWA	RYSUNEK I WYMIARY																																																																																																				
TR90	Trójknik 90°	 <p style="text-align: right;">KOMINUS®</p> <p style="text-align: right;">Tabela wymiarów</p> <table border="1"> <tr> <td>øD mm</td> <td>80</td><td>90</td><td>100</td><td>113</td><td>120</td><td>130</td><td>140</td><td>150</td><td>160</td><td>180</td><td>200</td><td>225</td><td>250</td><td>280</td><td>300</td><td>350</td><td>400</td><td>450</td><td>500</td> </tr> <tr> <td>L mm</td> <td>250</td><td>250</td><td>250</td><td>280</td><td>280</td><td>280</td><td>330</td><td>330</td><td>330</td><td>350</td><td>400</td><td>400</td><td>430</td><td>460</td><td>480</td><td>530</td><td>580</td><td>630</td><td>680</td> </tr> <tr> <td>C mm</td> <td>150</td><td>150</td><td>150</td><td>150</td><td>155</td><td>160</td><td>160</td><td>170</td><td>170</td><td>180</td><td>190</td><td>200</td><td>215</td><td>230</td><td>240</td><td>265</td><td>290</td><td>315</td><td>340</td> </tr> </table>	øD mm	80	90	100	113	120	130	140	150	160	180	200	225	250	280	300	350	400	450	500	L mm	250	250	250	280	280	280	330	330	330	350	400	400	430	460	480	530	580	630	680	C mm	150	150	150	150	155	160	160	170	170	180	190	200	215	230	240	265	290	315	340																																								
øD mm	80	90	100	113	120	130	140	150	160	180	200	225	250	280	300	350	400	450	500																																																																																			
L mm	250	250	250	280	280	280	330	330	330	350	400	400	430	460	480	530	580	630	680																																																																																			
C mm	150	150	150	150	155	160	160	170	170	180	190	200	215	230	240	265	290	315	340																																																																																			
WTD	Wyczystka trójknikowa z dekle	 <p style="text-align: right;">KOMINUS®</p> <p style="text-align: right;">Tabela wymiarów</p> <table border="1"> <tr> <td>øD mm</td> <td>80</td><td>90</td><td>100</td><td>113</td><td>120</td><td>130</td><td>140</td><td>150</td><td>160</td><td>180</td><td>200</td><td>225</td><td>250</td><td>280</td><td>300</td><td>350</td><td>400</td><td>450</td><td>500</td> </tr> <tr> <td>øD1 mm</td> <td>80</td><td>90</td><td>100</td><td>113</td><td>120</td><td>130</td><td>140</td><td>150</td><td>160</td><td>180</td><td>180</td><td colspan="8">200</td> </tr> <tr> <td>L mm</td> <td>260</td><td>270</td><td>280</td><td>300</td><td>300</td><td>310</td><td>320</td><td>330</td><td>340</td><td>360</td><td colspan="9">380</td> </tr> <tr> <td>C mm</td> <td>70</td><td>75</td><td>80</td><td>87</td><td>90</td><td>95</td><td>100</td><td>105</td><td>110</td><td>120</td><td>130</td><td>143</td><td>155</td><td>170</td><td>180</td><td>205</td><td>230</td><td>255</td><td>280</td> </tr> </table>	øD mm	80	90	100	113	120	130	140	150	160	180	200	225	250	280	300	350	400	450	500	øD1 mm	80	90	100	113	120	130	140	150	160	180	180	200								L mm	260	270	280	300	300	310	320	330	340	360	380									C mm	70	75	80	87	90	95	100	105	110	120	130	143	155	170	180	205	230	255	280																				
øD mm	80	90	100	113	120	130	140	150	160	180	200	225	250	280	300	350	400	450	500																																																																																			
øD1 mm	80	90	100	113	120	130	140	150	160	180	180	200																																																																																										
L mm	260	270	280	300	300	310	320	330	340	360	380																																																																																											
C mm	70	75	80	87	90	95	100	105	110	120	130	143	155	170	180	205	230	255	280																																																																																			
W	Wyczystka	 <p style="text-align: right;">KOMINUS®</p> <p style="text-align: right;">Tabela wymiarów</p> <table border="1"> <tr> <td>øD mm</td> <td>80</td><td>90</td><td>100</td><td>113</td><td>120</td><td>130</td><td>140</td><td>150</td><td>160</td><td>180</td><td>200</td><td>225</td><td>250</td><td>280</td><td>300</td><td>350</td><td>400</td><td>450</td><td>500</td> </tr> <tr> <td>AxB mm</td> <td colspan="19">140x140 / 280x140</td> </tr> <tr> <td>L mm</td> <td colspan="19">330 / 470</td> </tr> <tr> <td>L1 mm</td> <td colspan="19">90</td> </tr> <tr> <td>C mm</td> <td>140</td><td>145</td><td>150</td><td>155</td><td>160</td><td>165</td><td>170</td><td>175</td><td>180</td><td>190</td><td>200</td><td>212</td><td>225</td><td>240</td><td>250</td><td>275</td><td>300</td><td>325</td><td>350</td> </tr> </table>	øD mm	80	90	100	113	120	130	140	150	160	180	200	225	250	280	300	350	400	450	500	AxB mm	140x140 / 280x140																			L mm	330 / 470																			L1 mm	90																			C mm	140	145	150	155	160	165	170	175	180	190	200	212	225	240	250	275	300	325	350
øD mm	80	90	100	113	120	130	140	150	160	180	200	225	250	280	300	350	400	450	500																																																																																			
AxB mm	140x140 / 280x140																																																																																																					
L mm	330 / 470																																																																																																					
L1 mm	90																																																																																																					
C mm	140	145	150	155	160	165	170	175	180	190	200	212	225	240	250	275	300	325	350																																																																																			

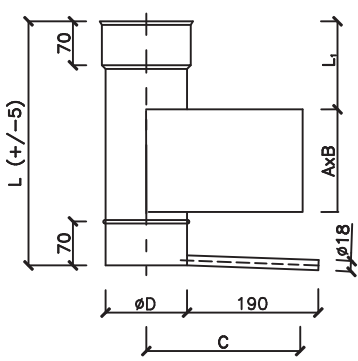
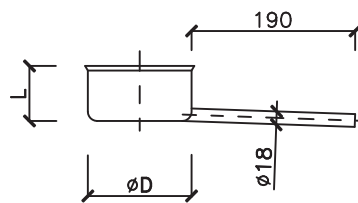
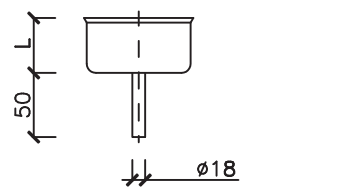
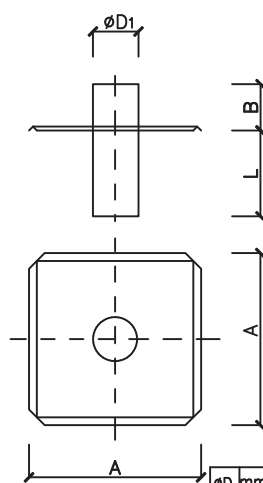
SYMBOL	NAZWA	RYSUNEK I WYMIARY																																																																																																				
WO	Wyczystka z odskraplaczem	 <p style="text-align: right;">KOMINUS®</p> <p style="text-align: center;">Tabela wymiarów</p> <table border="1"> <tr> <td>ØD mm</td> <td>80</td><td>90</td><td>100</td><td>113</td><td>120</td><td>130</td><td>140</td><td>150</td><td>160</td><td>180</td><td>200</td><td>225</td><td>250</td><td>280</td><td>300</td><td>350</td><td>400</td><td>450</td><td>500</td> </tr> <tr> <td>AxB mm</td> <td colspan="19">140x140 / 280x140</td> </tr> <tr> <td>L mm</td> <td colspan="19">330 / 470</td> </tr> <tr> <td>L₁ mm</td> <td colspan="19">90</td> </tr> <tr> <td>C mm</td> <td>140</td><td>145</td><td>150</td><td>155</td><td>160</td><td>165</td><td>170</td><td>175</td><td>180</td><td>190</td><td>200</td><td>212</td><td>225</td><td>240</td><td>250</td><td>275</td><td>300</td><td>325</td><td>350</td> </tr> </table>	ØD mm	80	90	100	113	120	130	140	150	160	180	200	225	250	280	300	350	400	450	500	AxB mm	140x140 / 280x140																			L mm	330 / 470																			L ₁ mm	90																			C mm	140	145	150	155	160	165	170	175	180	190	200	212	225	240	250	275	300	325	350
ØD mm	80	90	100	113	120	130	140	150	160	180	200	225	250	280	300	350	400	450	500																																																																																			
AxB mm	140x140 / 280x140																																																																																																					
L mm	330 / 470																																																																																																					
L ₁ mm	90																																																																																																					
C mm	140	145	150	155	160	165	170	175	180	190	200	212	225	240	250	275	300	325	350																																																																																			
O	Denko z odskraplaczem	  <p style="text-align: right;">KOMINUS®</p> <p style="text-align: center;">Tabela wymiarów</p> <table border="1"> <tr> <td>ØD mm</td> <td>80</td><td>90</td><td>100</td><td>113</td><td>120</td><td>130</td><td>140</td><td>150</td><td>160</td><td>180</td><td>200</td><td>225</td><td>250</td><td>280</td><td>300</td><td>350</td><td>400</td><td>450</td><td>500</td> </tr> <tr> <td>L mm</td> <td colspan="19">60</td> </tr> <tr> <td>L₁ mm</td> <td colspan="19">90</td> </tr> </table>	ØD mm	80	90	100	113	120	130	140	150	160	180	200	225	250	280	300	350	400	450	500	L mm	60																			L ₁ mm	90																																																										
ØD mm	80	90	100	113	120	130	140	150	160	180	200	225	250	280	300	350	400	450	500																																																																																			
L mm	60																																																																																																					
L ₁ mm	90																																																																																																					
PR	Przejście dachowe z rurą	 <p style="text-align: right;">KOMINUS®</p> <p style="text-align: center;">Tabela wymiarów</p> <table border="1"> <tr> <td>ØD mm</td> <td>80</td><td>90</td><td>100</td><td>113</td><td>120</td><td>130</td><td>140</td><td>150</td><td>160</td><td>180</td><td>200</td><td>225</td><td>250</td><td>280</td><td>300</td><td>350</td><td>400</td><td>450</td><td>500</td> </tr> <tr> <td>ØD1 mm</td> <td>90</td><td>100</td><td>113</td><td>120</td><td>130</td><td>140</td><td>150</td><td>160</td><td>170</td><td>190</td><td>210</td><td>235</td><td>260</td><td>290</td><td>310</td><td>360</td><td>410</td><td>460</td><td>510</td> </tr> <tr> <td>B mm</td> <td colspan="9">60</td><td colspan="10">80</td> </tr> <tr> <td>L mm</td> <td colspan="14">150</td><td colspan="5">200</td> </tr> </table>	ØD mm	80	90	100	113	120	130	140	150	160	180	200	225	250	280	300	350	400	450	500	ØD1 mm	90	100	113	120	130	140	150	160	170	190	210	235	260	290	310	360	410	460	510	B mm	60									80										L mm	150														200																								
ØD mm	80	90	100	113	120	130	140	150	160	180	200	225	250	280	300	350	400	450	500																																																																																			
ØD1 mm	90	100	113	120	130	140	150	160	170	190	210	235	260	290	310	360	410	460	510																																																																																			
B mm	60									80																																																																																												
L mm	150														200																																																																																							

SYMBOL	NAZWA	RYSUNEK I WYMIARY																																																																					
D	Daszek	<p style="text-align: right;">KOMINUS®</p> <p style="text-align: right;">Tabela wymiarów</p> <table border="1"> <thead> <tr> <th>ϕD mm</th> <th>80</th> <th>90</th> <th>100</th> <th>113</th> <th>120</th> <th>130</th> <th>140</th> <th>150</th> <th>160</th> <th>180</th> <th>200</th> <th>225</th> <th>250</th> <th>280</th> <th>300</th> <th>350</th> <th>400</th> <th>450</th> <th>500</th> </tr> </thead> <tbody> <tr> <td>H mm</td> <td colspan="9">120</td> <td colspan="3">180</td> <td colspan="3">250</td> <td colspan="3">300</td> </tr> <tr> <td>D2 mm</td> <td colspan="3">220</td> <td colspan="6">265</td> <td colspan="2">330</td> <td colspan="2">350</td> <td colspan="2">375</td> <td colspan="2">400</td> <td colspan="2">480</td> <td colspan="2">500</td> <td colspan="2">550</td> <td colspan="2">600</td> <td colspan="2">650</td> <td colspan="2">700</td> </tr> </tbody> </table>	ϕD mm	80	90	100	113	120	130	140	150	160	180	200	225	250	280	300	350	400	450	500	H mm	120									180			250			300			D2 mm	220			265						330		350		375		400		480		500		550		600		650		700	
ϕD mm	80	90	100	113	120	130	140	150	160	180	200	225	250	280	300	350	400	450	500																																																				
H mm	120									180			250			300																																																							
D2 mm	220			265						330		350		375		400		480		500		550		600		650		700																																											
L	Łapacz iskier	<p style="text-align: right;">KOMINUS®</p> <p style="text-align: right;">Tabela wymiarów</p> <table border="1"> <thead> <tr> <th>ϕD mm</th> <th>80</th> <th>90</th> <th>100</th> <th>113</th> <th>120</th> <th>130</th> <th>140</th> <th>150</th> <th>160</th> <th>180</th> <th>200</th> <th>225</th> <th>250</th> <th>280</th> <th>300</th> <th>350</th> <th>400</th> <th>450</th> <th>500</th> </tr> </thead> <tbody> <tr> <td>H mm</td> <td colspan="9">120</td> <td colspan="3">180</td> <td colspan="3">250</td> <td colspan="3">300</td> </tr> <tr> <td>D2 mm</td> <td colspan="3">220</td> <td colspan="6">265</td> <td colspan="2">330</td> <td colspan="2">350</td> <td colspan="2">375</td> <td colspan="2">400</td> <td colspan="2">480</td> <td colspan="2">500</td> <td colspan="2">550</td> <td colspan="2">600</td> <td colspan="2">650</td> <td colspan="2">700</td> </tr> </tbody> </table>	ϕD mm	80	90	100	113	120	130	140	150	160	180	200	225	250	280	300	350	400	450	500	H mm	120									180			250			300			D2 mm	220			265						330		350		375		400		480		500		550		600		650		700	
ϕD mm	80	90	100	113	120	130	140	150	160	180	200	225	250	280	300	350	400	450	500																																																				
H mm	120									180			250			300																																																							
D2 mm	220			265						330		350		375		400		480		500		550		600		650		700																																											
K30	Kolano 30°	<p style="text-align: right;">KOMINUS®</p> <p style="text-align: right;">Tabela wymiarów</p> <table border="1"> <thead> <tr> <th>ϕD mm</th> <th>80</th> <th>90</th> <th>100</th> <th>113</th> <th>120</th> <th>130</th> <th>140</th> <th>150</th> <th>160</th> <th>180</th> <th>200</th> <th>225</th> <th>250</th> <th>280</th> <th>300</th> <th>350</th> <th>400</th> <th>450</th> <th>500</th> </tr> </thead> <tbody> <tr> <td>A mm</td> <td>51</td> <td>51</td> <td>52</td> <td>53</td> <td>53</td> <td>54</td> <td>55</td> <td>56</td> <td>56</td> <td>58</td> <td>59</td> <td>61</td> <td>63</td> <td>65</td> <td>66</td> <td>70</td> <td>73</td> <td>77</td> <td>80</td> </tr> <tr> <td>B mm</td> <td>188</td> <td>191</td> <td>193</td> <td>196</td> <td>198</td> <td>201</td> <td>203</td> <td>206</td> <td>208</td> <td>213</td> <td>218</td> <td>224</td> <td>231</td> <td>238</td> <td>243</td> <td>256</td> <td>268</td> <td>281</td> <td>293</td> </tr> </tbody> </table>	ϕD mm	80	90	100	113	120	130	140	150	160	180	200	225	250	280	300	350	400	450	500	A mm	51	51	52	53	53	54	55	56	56	58	59	61	63	65	66	70	73	77	80	B mm	188	191	193	196	198	201	203	206	208	213	218	224	231	238	243	256	268	281	293									
ϕD mm	80	90	100	113	120	130	140	150	160	180	200	225	250	280	300	350	400	450	500																																																				
A mm	51	51	52	53	53	54	55	56	56	58	59	61	63	65	66	70	73	77	80																																																				
B mm	188	191	193	196	198	201	203	206	208	213	218	224	231	238	243	256	268	281	293																																																				

SYMBOL	NAZWA	RYSUNEK I WYMIARY																																																												
K45	Kolano 45°	<p style="text-align: right;">KOMINUS®</p> <p style="text-align: center;">Tabela wymiarów</p> <table border="1"> <tr> <td>ØD mm</td> <td>80</td><td>90</td><td>100</td><td>113</td><td>120</td><td>130</td><td>140</td><td>150</td><td>160</td><td>180</td><td>200</td><td>225</td><td>250</td><td>280</td><td>300</td><td>350</td><td>400</td><td>450</td><td>500</td> </tr> <tr> <td>A mm</td> <td>76</td><td>77</td><td>79</td><td>80</td><td>82</td><td>83</td><td>85</td><td>86</td><td>88</td><td>90</td><td>93</td><td>97</td><td>101</td><td>105</td><td>108</td><td>115</td><td>122</td><td>130</td><td>137</td> </tr> <tr> <td>B mm</td> <td>183</td><td>187</td><td>190</td><td>194</td><td>198</td><td>201</td><td>205</td><td>208</td><td>212</td><td>219</td><td>226</td><td>235</td><td>244</td><td>254</td><td>261</td><td>279</td><td>297</td><td>314</td><td>332</td> </tr> </table>	ØD mm	80	90	100	113	120	130	140	150	160	180	200	225	250	280	300	350	400	450	500	A mm	76	77	79	80	82	83	85	86	88	90	93	97	101	105	108	115	122	130	137	B mm	183	187	190	194	198	201	205	208	212	219	226	235	244	254	261	279	297	314	332
ØD mm	80	90	100	113	120	130	140	150	160	180	200	225	250	280	300	350	400	450	500																																											
A mm	76	77	79	80	82	83	85	86	88	90	93	97	101	105	108	115	122	130	137																																											
B mm	183	187	190	194	198	201	205	208	212	219	226	235	244	254	261	279	297	314	332																																											
K60	Kolano 60°	<p style="text-align: right;">KOMINUS®</p> <p style="text-align: center;">Tabela wymiarów</p> <table border="1"> <tr> <td>ØD mm</td> <td>80</td><td>90</td><td>100</td><td>113</td><td>120</td><td>130</td><td>140</td><td>150</td><td>160</td><td>180</td><td>200</td><td>225</td><td>250</td><td>280</td><td>300</td><td>350</td><td>400</td><td>450</td><td>500</td> </tr> <tr> <td>A mm</td> <td>118</td><td>121</td><td>123</td><td>126</td><td>128</td><td>131</td><td>133</td><td>136</td><td>138</td><td>143</td><td>148</td><td>154</td><td>161</td><td>168</td><td>173</td><td>186</td><td>198</td><td>211</td><td>223</td> </tr> <tr> <td>B mm</td> <td>205</td><td>209</td><td>213</td><td>218</td><td>222</td><td>226</td><td>231</td><td>235</td><td>239</td><td>248</td><td>257</td><td>268</td><td>278</td><td>291</td><td>300</td><td>322</td><td>343</td><td>365</td><td>387</td> </tr> </table>	ØD mm	80	90	100	113	120	130	140	150	160	180	200	225	250	280	300	350	400	450	500	A mm	118	121	123	126	128	131	133	136	138	143	148	154	161	168	173	186	198	211	223	B mm	205	209	213	218	222	226	231	235	239	248	257	268	278	291	300	322	343	365	387
ØD mm	80	90	100	113	120	130	140	150	160	180	200	225	250	280	300	350	400	450	500																																											
A mm	118	121	123	126	128	131	133	136	138	143	148	154	161	168	173	186	198	211	223																																											
B mm	205	209	213	218	222	226	231	235	239	248	257	268	278	291	300	322	343	365	387																																											
K90	Kolano 90°	<p style="text-align: right;">KOMINUS®</p> <p style="text-align: center;">Tabela wymiarów</p> <table border="1"> <tr> <td>ØD mm</td> <td>80</td><td>90</td><td>100</td><td>113</td><td>120</td><td>130</td><td>140</td><td>150</td><td>160</td><td>180</td><td>200</td><td>225</td><td>250</td><td>280</td><td>300</td><td>350</td><td>400</td><td>450</td><td>500</td> </tr> <tr> <td>A mm</td> <td>160</td><td>165</td><td>170</td><td>175</td><td>180</td><td>185</td><td>190</td><td>195</td><td>200</td><td>210</td><td>220</td><td>233</td><td>245</td><td>260</td><td>270</td><td>295</td><td>320</td><td>345</td><td>370</td> </tr> <tr> <td>B mm</td> <td>160</td><td>165</td><td>170</td><td>175</td><td>180</td><td>185</td><td>190</td><td>195</td><td>200</td><td>210</td><td>220</td><td>233</td><td>245</td><td>260</td><td>270</td><td>295</td><td>320</td><td>345</td><td>370</td> </tr> </table>	ØD mm	80	90	100	113	120	130	140	150	160	180	200	225	250	280	300	350	400	450	500	A mm	160	165	170	175	180	185	190	195	200	210	220	233	245	260	270	295	320	345	370	B mm	160	165	170	175	180	185	190	195	200	210	220	233	245	260	270	295	320	345	370
ØD mm	80	90	100	113	120	130	140	150	160	180	200	225	250	280	300	350	400	450	500																																											
A mm	160	165	170	175	180	185	190	195	200	210	220	233	245	260	270	295	320	345	370																																											
B mm	160	165	170	175	180	185	190	195	200	210	220	233	245	260	270	295	320	345	370																																											

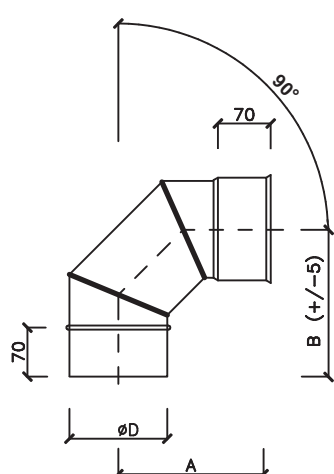
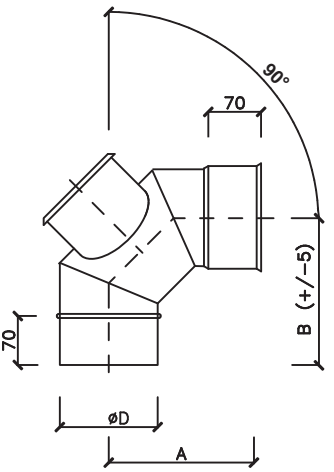
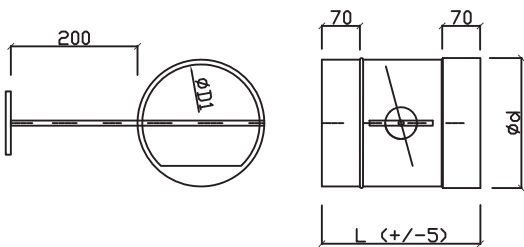
SYMBOL	NAZWA	RYSUNEK I WYMIARY																																																												
KN90	Kolano regulowane 90°	 <p style="text-align: right;">KOMINUS®</p> <p style="text-align: right;">Tabela wymiarów</p> <table border="1"> <tr> <td>ØD mm</td> <td>80</td> <td>90</td> <td>100</td> <td>113</td> <td>120</td> <td>130</td> <td>140</td> <td>150</td> <td>160</td> <td>180</td> <td>200</td> <td>225</td> <td>250</td> <td>280</td> <td>300</td> <td>350</td> <td>400</td> <td>450</td> <td>500</td> </tr> <tr> <td>A mm</td> <td>160</td> <td>165</td> <td>170</td> <td>175</td> <td>180</td> <td>185</td> <td>190</td> <td>195</td> <td>200</td> <td>210</td> <td>220</td> <td>233</td> <td>245</td> <td>260</td> <td>270</td> <td>295</td> <td>320</td> <td>345</td> <td>370</td> </tr> <tr> <td>B mm</td> <td>160</td> <td>165</td> <td>170</td> <td>175</td> <td>180</td> <td>185</td> <td>190</td> <td>195</td> <td>200</td> <td>210</td> <td>220</td> <td>233</td> <td>245</td> <td>260</td> <td>270</td> <td>295</td> <td>320</td> <td>345</td> <td>370</td> </tr> </table>	ØD mm	80	90	100	113	120	130	140	150	160	180	200	225	250	280	300	350	400	450	500	A mm	160	165	170	175	180	185	190	195	200	210	220	233	245	260	270	295	320	345	370	B mm	160	165	170	175	180	185	190	195	200	210	220	233	245	260	270	295	320	345	370
ØD mm	80	90	100	113	120	130	140	150	160	180	200	225	250	280	300	350	400	450	500																																											
A mm	160	165	170	175	180	185	190	195	200	210	220	233	245	260	270	295	320	345	370																																											
B mm	160	165	170	175	180	185	190	195	200	210	220	233	245	260	270	295	320	345	370																																											
KW90	Kolano 90° z wyczystką	 <p style="text-align: right;">KOMINUS®</p> <p style="text-align: right;">Tabela wymiarów</p> <table border="1"> <tr> <td>ØD mm</td> <td>80</td> <td>90</td> <td>100</td> <td>113</td> <td>120</td> <td>130</td> <td>140</td> <td>150</td> <td>160</td> <td>180</td> <td>200</td> <td>225</td> <td>250</td> <td>280</td> <td>300</td> <td>350</td> <td>400</td> <td>450</td> <td>500</td> </tr> <tr> <td>A mm</td> <td>160</td> <td>165</td> <td>170</td> <td>175</td> <td>180</td> <td>185</td> <td>190</td> <td>195</td> <td>200</td> <td>210</td> <td>220</td> <td>233</td> <td>245</td> <td>260</td> <td>270</td> <td>295</td> <td>320</td> <td>345</td> <td>370</td> </tr> <tr> <td>B mm</td> <td>160</td> <td>165</td> <td>170</td> <td>175</td> <td>180</td> <td>185</td> <td>190</td> <td>195</td> <td>200</td> <td>210</td> <td>220</td> <td>233</td> <td>245</td> <td>260</td> <td>270</td> <td>295</td> <td>320</td> <td>345</td> <td>370</td> </tr> </table>	ØD mm	80	90	100	113	120	130	140	150	160	180	200	225	250	280	300	350	400	450	500	A mm	160	165	170	175	180	185	190	195	200	210	220	233	245	260	270	295	320	345	370	B mm	160	165	170	175	180	185	190	195	200	210	220	233	245	260	270	295	320	345	370
ØD mm	80	90	100	113	120	130	140	150	160	180	200	225	250	280	300	350	400	450	500																																											
A mm	160	165	170	175	180	185	190	195	200	210	220	233	245	260	270	295	320	345	370																																											
B mm	160	165	170	175	180	185	190	195	200	210	220	233	245	260	270	295	320	345	370																																											
S	Przepustnica	 <p style="text-align: right;">KOMINUS®</p> <p style="text-align: right;">Tabela wymiarów</p> <table border="1"> <tr> <td>Ød mm</td> <td>113</td> <td>120</td> <td>130</td> <td>140</td> <td>150</td> <td>160</td> <td>180</td> <td>200</td> <td>225</td> <td>250</td> <td>300</td> <td>350</td> <td>400</td> <td>450</td> <td>500</td> </tr> <tr> <td>ØD1 mm</td> <td>100</td> <td>105</td> <td>115</td> <td>125</td> <td>135</td> <td>145</td> <td>165</td> <td>185</td> <td>210</td> <td>235</td> <td>285</td> <td>335</td> <td>385</td> <td>435</td> <td>485</td> </tr> <tr> <td>L mm</td> <td colspan="6">250</td> <td>300</td> <td>300</td> <td>350</td> <td>400</td> <td>450</td> <td>500</td> <td>550</td> <td>600</td> </tr> </table>	Ød mm	113	120	130	140	150	160	180	200	225	250	300	350	400	450	500	ØD1 mm	100	105	115	125	135	145	165	185	210	235	285	335	385	435	485	L mm	250						300	300	350	400	450	500	550	600													
Ød mm	113	120	130	140	150	160	180	200	225	250	300	350	400	450	500																																															
ØD1 mm	100	105	115	125	135	145	165	185	210	235	285	335	385	435	485																																															
L mm	250						300	300	350	400	450	500	550	600																																																

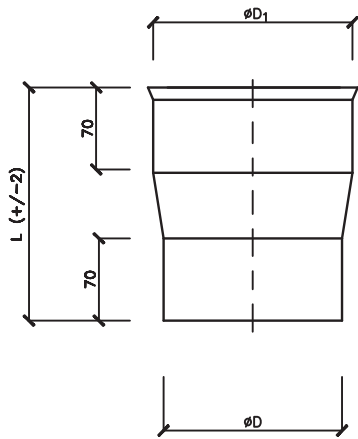
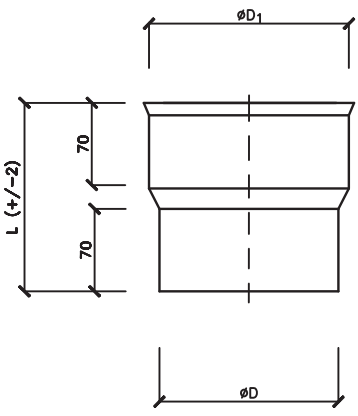
SYMBOL	NAZWA	RYSUNEK I WYMIARY
<p>RS</p>	<p>Złączka, redukcja stożkowa</p>	 <p style="text-align: right;">KOMINUS®</p> <p style="text-align: right;">Tabela wymiarów</p> <hr/> <p style="text-align: right;">Wg zamówienia Klienta</p>
<p>RR</p>	<p>Złączka, redukcja rozciągana</p>	 <p style="text-align: right;">KOMINUS®</p> <p style="text-align: right;">Tabela wymiarów</p> <hr/> <p style="text-align: right;">Wg zamówienia Klienta</p>

Akcesoria kominowe KA.



KA

Kody katalogowe akcesoriów kominowych.



Tabela 1

Symbol	Gr. izolacji
I3	30mm
I5	50mm
I7	75mm

Tabela 2

Symbol	Grubość
A	0,4 mm
B	0,5 mm
C	0,6 mm
D	0,8 mm
E	1,0 mm
F	1,5 mm
G	2,0 mm
X	inne

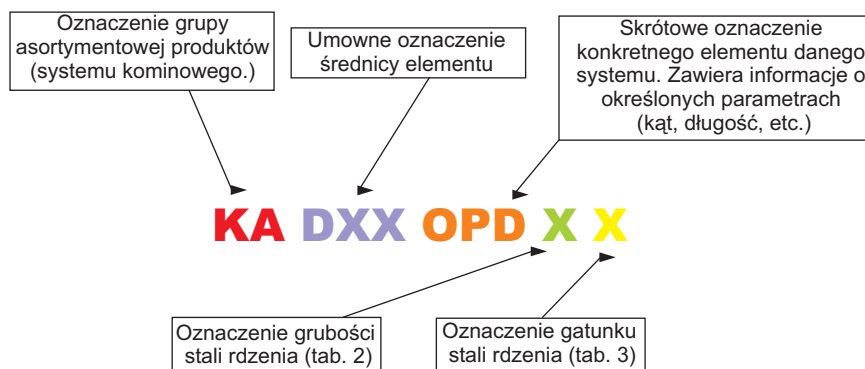
Tabela 3

Symbol	Gatunek
1	1,4404
2	1,4301
3	1,4509
4	1,4828
5	ocynk
6	ocynk RAL
7	miedź
8	aluminium
9	S235JRGZ
0	inne

SYMBOL	NAZWA	RYSUNEK I WYMIARY																																																													
P	Przejście dachowe proste	<p>Tabela wymiarów</p> <table border="1"> <tr> <td>ϕD mm</td> <td>80</td><td>90</td><td>100</td><td>113</td><td>120</td><td>130</td><td>140</td><td>150</td><td>160</td><td>180</td><td>200</td><td>225</td><td>250</td><td>280</td><td>300</td><td>350</td><td>400</td><td>450</td><td>500</td> </tr> <tr> <td>ϕD_1 mm</td> <td>90</td><td>100</td><td>113</td><td>120</td><td>130</td><td>140</td><td>150</td><td>160</td><td>170</td><td>190</td><td>210</td><td>235</td><td>260</td><td>290</td><td>310</td><td>360</td><td>410</td><td>460</td><td>510</td> </tr> <tr> <td>A mm</td> <td colspan="4">250x250</td><td colspan="4">300</td><td>310</td><td>320</td><td>340</td><td>360</td><td>385</td><td>410</td><td>440</td><td>460</td><td>510</td><td>560</td><td>610</td><td>660</td> </tr> </table>	ϕD mm	80	90	100	113	120	130	140	150	160	180	200	225	250	280	300	350	400	450	500	ϕD_1 mm	90	100	113	120	130	140	150	160	170	190	210	235	260	290	310	360	410	460	510	A mm	250x250				300				310	320	340	360	385	410	440	460	510	560	610	660
ϕD mm	80	90	100	113	120	130	140	150	160	180	200	225	250	280	300	350	400	450	500																																												
ϕD_1 mm	90	100	113	120	130	140	150	160	170	190	210	235	260	290	310	360	410	460	510																																												
A mm	250x250				300				310	320	340	360	385	410	440	460	510	560	610	660																																											
OPD	Osłona przeciwdeszczowa komina	<p>Tabela wymiarów</p> <table border="1"> <tr> <td>ϕD mm</td> <td>80</td><td>90</td><td>100</td><td>113</td><td>120</td><td>130</td><td>140</td><td>150</td><td>160</td><td>180</td><td>200</td><td>225</td><td>250</td><td>280</td><td>300</td><td>350</td><td>400</td><td>450</td><td>500</td> </tr> <tr> <td>D_1 mm</td> <td>150</td><td>160</td><td>170</td><td>180</td><td>190</td><td>200</td><td>210</td><td>220</td><td>230</td><td>240</td><td>270</td><td>295</td><td>320</td><td>350</td><td>370</td><td>420</td><td>470</td><td>520</td><td>570</td> </tr> <tr> <td>H mm</td> <td colspan="19">72</td> </tr> </table>	ϕD mm	80	90	100	113	120	130	140	150	160	180	200	225	250	280	300	350	400	450	500	D_1 mm	150	160	170	180	190	200	210	220	230	240	270	295	320	350	370	420	470	520	570	H mm	72																			
ϕD mm	80	90	100	113	120	130	140	150	160	180	200	225	250	280	300	350	400	450	500																																												
D_1 mm	150	160	170	180	190	200	210	220	230	240	270	295	320	350	370	420	470	520	570																																												
H mm	72																																																														
RZ	Rozeta	<p>Tabela wymiarów</p> <table border="1"> <tr> <td>ϕd mm</td> <td>113</td><td>120</td><td>130</td><td>140</td><td>150</td><td>160</td><td>180</td><td>200</td><td>225</td><td>250</td><td>300</td><td>350</td><td>400</td><td>450</td><td>500</td> </tr> <tr> <td>H mm</td> <td colspan="15">36</td> </tr> </table>	ϕd mm	113	120	130	140	150	160	180	200	225	250	300	350	400	450	500	H mm	36																																											
ϕd mm	113	120	130	140	150	160	180	200	225	250	300	350	400	450	500																																																
H mm	36																																																														

SYMBOL	NAZWA	RYSUNEK I WYMIARY																
PW	Przedłużenie wyczystki	<p>Tabela wymiarów</p> <p>L = 100, 250, 333, 500, 1000</p>																
DW	Drzwi wyczystki																	
OM	Obejma mocująca	<p>Tabela wymiarów</p> <table border="1"> <tr> <td>ød mm</td> <td>113</td> <td>120</td> <td>130</td> <td>140</td> <td>150</td> <td>160</td> <td>180</td> <td>200</td> <td>225</td> <td>250</td> <td>300</td> <td>350</td> <td>400</td> <td>450</td> <td>500</td> </tr> </table>	ød mm	113	120	130	140	150	160	180	200	225	250	300	350	400	450	500
ød mm	113	120	130	140	150	160	180	200	225	250	300	350	400	450	500			

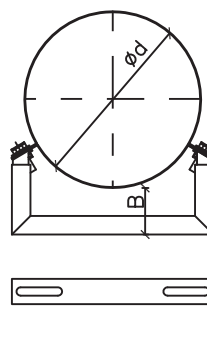
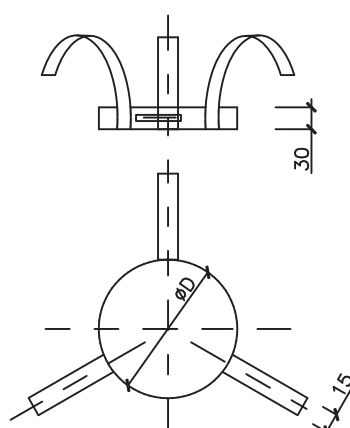
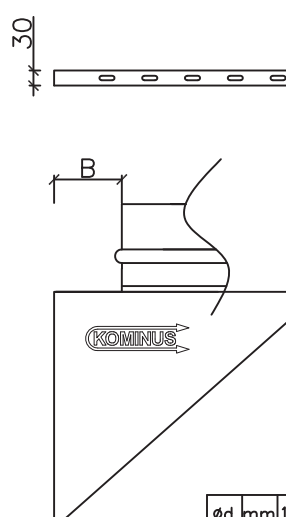
SYMBOL	NAZWA	RYSUNEK I WYMIARY																																																																																																
ON	Obejma mocująca nastawna	 <p style="text-align: right;">KOMINUS®</p> <p style="text-align: right;">Tabela wymiarów</p> <table border="1"> <tr> <th>ϕd mm</th> <td>113</td><td>120</td><td>130</td><td>140</td><td>150</td><td>160</td><td>180</td><td>200</td><td>225</td><td>250</td><td>300</td><td>350</td><td>400</td><td>450</td><td>500</td> </tr> <tr> <td></td> <td colspan="7" style="text-align: center;">B_{min}</td> <td colspan="8" style="text-align: center;">B_{max}</td> </tr> <tr> <td>Wyk. 1</td> <td colspan="7" style="text-align: center;">50</td> <td colspan="8" style="text-align: center;">100</td> </tr> <tr> <td>Wyk. 2</td> <td colspan="7" style="text-align: center;">100</td> <td colspan="8" style="text-align: center;">200</td> </tr> <tr> <td>Wyk. 3</td> <td colspan="7" style="text-align: center;">200</td> <td colspan="8" style="text-align: center;">350</td> </tr> <tr> <td>Wyk. 4</td> <td colspan="7" style="text-align: center;">350</td> <td colspan="8" style="text-align: center;">500</td> </tr> </table>	ϕd mm	113	120	130	140	150	160	180	200	225	250	300	350	400	450	500		B_{min}							B_{max}								Wyk. 1	50							100								Wyk. 2	100							200								Wyk. 3	200							350								Wyk. 4	350							500							
ϕd mm	113	120	130	140	150	160	180	200	225	250	300	350	400	450	500																																																																																			
	B_{min}							B_{max}																																																																																										
Wyk. 1	50							100																																																																																										
Wyk. 2	100							200																																																																																										
Wyk. 3	200							350																																																																																										
Wyk. 4	350							500																																																																																										
OC	Obejma centrująca	 <p style="text-align: right;">KOMINUS®</p> <p style="text-align: right;">Tabela wymiarów</p> <table border="1"> <tr> <th>ϕD mm</th> <td>80</td><td>90</td><td>100</td><td>110</td><td>120</td><td>130</td><td>140</td><td>150</td><td>160</td><td>180</td><td>200</td><td>225</td><td>250</td><td>280</td><td>300</td><td>350</td><td>400</td><td>450</td><td>500</td> </tr> </table> <p style="text-align: center;">Wg zamówienia Klienta</p>	ϕD mm	80	90	100	110	120	130	140	150	160	180	200	225	250	280	300	350	400	450	500																																																																												
ϕD mm	80	90	100	110	120	130	140	150	160	180	200	225	250	280	300	350	400	450	500																																																																															
KVS	Konsola wsporcza	 <p style="text-align: right;">KOMINUS®</p> <p style="text-align: right;">Tabela wymiarów</p> <table border="1"> <tr> <th>ϕd mm</th> <td>113</td><td>120</td><td>130</td><td>140</td><td>150</td><td>160</td><td>180</td><td>200</td><td>225</td><td>250</td><td>300</td><td>350</td><td>400</td><td>450</td><td>500</td> </tr> <tr> <th>B mm</th> <td colspan="15" style="text-align: center;">100</td> </tr> </table>	ϕd mm	113	120	130	140	150	160	180	200	225	250	300	350	400	450	500	B mm	100																																																																														
ϕd mm	113	120	130	140	150	160	180	200	225	250	300	350	400	450	500																																																																																			
B mm	100																																																																																																	

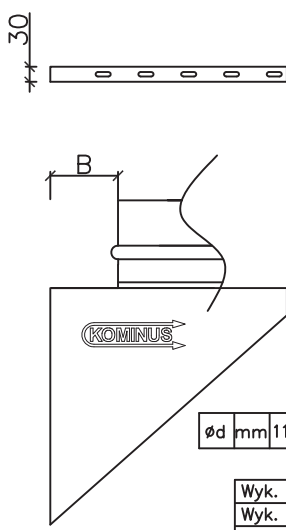
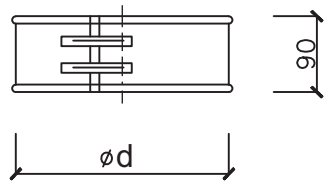
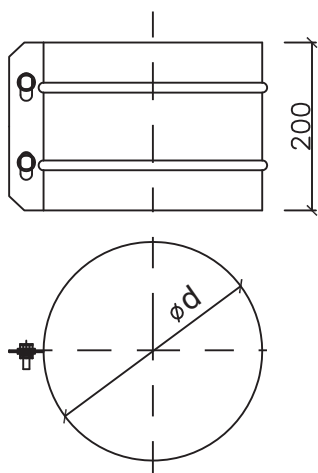
SYMBOL	NAZWA	RYSUNEK I WYMIARY																																																																																																
KV	Konsola wsporcza nastawna	 <p style="text-align: right;">KOMINUS®</p> <p style="text-align: right;">Tabela wymiarów</p> <table border="1"> <thead> <tr> <th>Ød mm</th> <th>113</th> <th>120</th> <th>130</th> <th>140</th> <th>150</th> <th>160</th> <th>180</th> <th>200</th> <th>225</th> <th>250</th> <th>300</th> <th>350</th> <th>400</th> <th>450</th> <th>500</th> </tr> </thead> <tbody> <tr> <td></td> <td colspan="7">B_{min}</td> <td colspan="8">B_{max}</td> </tr> <tr> <td>Wyk. 1</td> <td colspan="7">50</td> <td colspan="8">100</td> </tr> <tr> <td>Wyk. 2</td> <td colspan="7">100</td> <td colspan="8">200</td> </tr> <tr> <td>Wyk. 3</td> <td colspan="7">200</td> <td colspan="8">350</td> </tr> <tr> <td>Wyk. 4</td> <td colspan="7">350</td> <td colspan="8">500</td> </tr> </tbody> </table>	Ød mm	113	120	130	140	150	160	180	200	225	250	300	350	400	450	500		B _{min}							B _{max}								Wyk. 1	50							100								Wyk. 2	100							200								Wyk. 3	200							350								Wyk. 4	350							500							
Ød mm	113	120	130	140	150	160	180	200	225	250	300	350	400	450	500																																																																																			
	B _{min}							B _{max}																																																																																										
Wyk. 1	50							100																																																																																										
Wyk. 2	100							200																																																																																										
Wyk. 3	200							350																																																																																										
Wyk. 4	350							500																																																																																										
ZM	Zacisk montażowy	 <p style="text-align: right;">KOMINUS®</p> <p style="text-align: right;">Tabela wymiarów</p> <table border="1"> <thead> <tr> <th>Ød mm</th> <th>113</th> <th>120</th> <th>130</th> <th>140</th> <th>150</th> <th>160</th> <th>180</th> <th>200</th> <th>225</th> <th>250</th> <th>300</th> <th>350</th> <th>400</th> <th>450</th> <th>500</th> </tr> </thead> </table>	Ød mm	113	120	130	140	150	160	180	200	225	250	300	350	400	450	500																																																																																
Ød mm	113	120	130	140	150	160	180	200	225	250	300	350	400	450	500																																																																																			
ZMW	Zacisk montażowy wzmocniony	 <p style="text-align: right;">KOMINUS®</p> <p style="text-align: right;">Tabela wymiarów</p> <table border="1"> <thead> <tr> <th>Ød mm</th> <th>113</th> <th>120</th> <th>130</th> <th>140</th> <th>150</th> <th>160</th> <th>180</th> <th>200</th> <th>225</th> <th>250</th> <th>300</th> <th>350</th> <th>400</th> <th>450</th> <th>500</th> </tr> </thead> </table>	Ød mm	113	120	130	140	150	160	180	200	225	250	300	350	400	450	500																																																																																
Ød mm	113	120	130	140	150	160	180	200	225	250	300	350	400	450	500																																																																																			

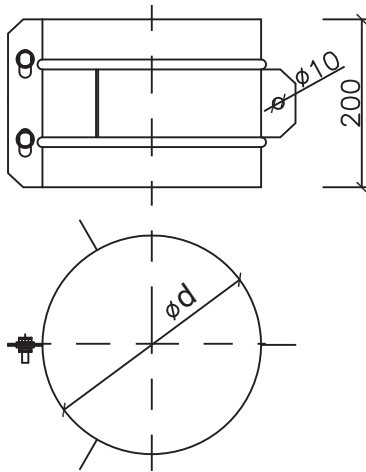
SYMBOL	NAZWA	RYSUNEK I WYMIARY																	
<p>ZMO</p>	<p>Zacisk montażowy do odciągów</p>	<div style="text-align: right;">  </div>  <p style="text-align: right;">Tabela wymiarów</p> <table border="1" data-bbox="852 842 1458 882"> <tr> <td>ød</td> <td>mm</td> <td>113</td> <td>120</td> <td>130</td> <td>140</td> <td>150</td> <td>160</td> <td>180</td> <td>200</td> <td>225</td> <td>250</td> <td>300</td> <td>350</td> <td>400</td> <td>450</td> <td>500</td> </tr> </table>	ød	mm	113	120	130	140	150	160	180	200	225	250	300	350	400	450	500
ød	mm	113	120	130	140	150	160	180	200	225	250	300	350	400	450	500			

NOTATKI

KOMINUS Sp. z o.o.
Łęzkowice 112
32-015 Kłaj, Poland
tel./fax: (+48) 12 284 27 73, 284 45 44

www.kominus.com.pl

